

## Comparison of Plasma Transferred Arc and Submerged Arc Welded Abrasive Wear Resistant Composite Hardfacings

Taavi SIMSON<sup>1\*</sup>, Priit KULU<sup>1</sup>, Andrei SURŽENKOV<sup>1</sup>, Antanas CIUPLYS<sup>2</sup>,  
Mart VILJUS<sup>1</sup>, Gintautas ZALDARYS<sup>2</sup>

<sup>1</sup> Department of Mechanical and Industrial Engineering, Tallinn University of Technology, Ehitajate tee 5, 19086 Tallinn, Estonia

<sup>2</sup> Department of Production Engineering, Kaunas University of Technology, Studentu str. 56, 51424 Kaunas, Lithuania

**crossref** <http://dx.doi.org/10.5755/j01.ms.24.2.19121>

Received 26 September 2017; accepted 18 December 2017

Composite hardfacings produced by Plasma Transferred Arc Welding (PTAW) and Submerged Arc Welding (SAW) possess a good combination of hardness, wear resistance and fracture toughness, thus providing high wear resistance. Although they cannot substitute and be compared with conventional WC-Co based hardmetals, still they can be used in many applications where high wear resistance, hardness and toughness are in great demand. In this study two different hardfacing production technologies PTAW and SAW, were used to produce the hardfacings for abrasive wear conditions. In both cases hardfacings were welded on the top of low alloy steel using different proportions of disintegrator milled hardmetal WC-Co powder of different fractions as a reinforcement and self-fluxing alloy as a matrix. They were analysed in regard to Rockwell and Vickers hardness, wear behaviour, and microstructural analysis. SAW hardfacings were subjected to Rockwell hardness test after process and after two cycles of tempering; secondary hardness effect was detected as increment of hardness values from 39 HRC to 58 HRC after first cycle of tempering. High Vickers hardness values did not correlate with wear results, as it commonly shows hardness of hardmetal particles. Dissolution of hardmetal particles in the matrix was observed in both PTAW and SAW hardfacings with higher amount in the later. This amount correlated with heat input during welding process. Wear test results in abrasive emery wear (AEMW) and abrasive wheel wear test (AWW) showed almost analogous tendency, with slightly lower wear in later. Both types of hardfacings have shown promising results in intensive wear conditions.

*Keywords:* hardfacing, plasma transfer arc welding, submerged arc welding, wear resistance, recycled powder.

### 1. INTRODUCTION

In the majority of wear parts applications there is a great demand for hard materials with superior wear resistance in the form of coatings or hardfacings [1]. Hardfacing procedure can be used for the production of new overlays as well as for restoration of worn surfaces [2, 3]. Different types of welding, brazing, powder metallurgy (liquid phase sintering), laser-cladding, thermal spraying, etc., are widely used for the production of hardfacings [4].

Among other hardfacing methods, welding is considered as an economical choice [5]. A solid wire is used as an electrode to form a hard high wear resistant layer on the surface of a substrate using different welding processes such as Gas Tungsten Arc Welding (GTAW), Flux Cored Arc Welding (FCAW), Gas Metal Arc Welding (GMAW) or Submerged Arc Welding (SAW). SAW is a fascinating method for the production of hardfacings because of its high deposition rates. The SAW hardfacing process may indeed mean melting a pre-placed highly alloyed powder, which contains elements such a chromium, carbon, molybdenum, tungsten, and manganese, by the electric arc under the layer of flux [6, 7].

Generally, SAW hardfacings are used in abrasion, erosion, corrosion or impact wear conditions: mineral processing, mining, cement production, and paper

manufacturing. Some of specific applications are similar to those of Plasma Transferred Arc Welded (PTAW) hardfacings such as crusher teeth, hydro transport screens, and pumps [8, 9].

In its turn, PTAW is among the favoured production technologies to produce hardfacings with lower manufacturing cost and higher productivity compared with thermal spraying, laser cladding or a similar technology [10]. The main advantages of these coatings are their density and high thickness that are necessary for mining, oil-sand industries, mixer blades, furnace chutes, etc. [11, 12]. PTAW iron-based hardfacings, reinforced with WC-Co particles, may provide over 9 times higher resistance to abrasive wear, than commonly used wear resistant steels [13]. This process normally uses powder mixture carried into the arc area using powder feeding system [6]. There are only a few different powder materials systems that are typical to PTAW and SAW: chromium carbide, WC-Ni and WC-Co, etc. Because of comparatively high price of PTAW equipment it is impractical to produce relatively low value added hardfacings such as chromium carbide overlays, therefore more expensive materials systems such a WC, WC-Co, self-fluxing alloys, Fe-Cr-C alloys, stellites, etc., are used; on the other hand, SAW technique is seldom used for production of tungsten carbide based coatings because of extremely high weld arc temperatures, which can initiate

\* Corresponding author. Tel.: +372-58-208242.  
E-mail address: [taavi.simson@ttu.ee](mailto:taavi.simson@ttu.ee) (T. Simson)

the dissolution of tungsten carbide. Considering process parameters: hardfacing rate, voltage, and feed rate a direct dependence was observed between the dissolution rate and the content of WC [14]. The maximum WC content of 19 % at dissolution rate of 5 % was only realised with low feed speed and voltage. In the case of the PTAW process, the WC content may approach 30 % [15].

Taking into account these considerations the main objective of presented study is applying two common welding technologies – PTAW and SAW – to produce hardfacings, compare and analyse mechanical their properties, formed microstructures and wear resistance in intensive abrasive emery wear and abrasive wheel wear conditions.

## 2. EXPERIMENTAL

Recycled (disintegrator milled) hardmetal WC-Co powder, with size of 1.6–2.0 mm (coarse fraction) and 0.16–0.315 mm (fine fraction) as reinforcement and commercial iron-based self-fluxing alloy powder with fraction size of 15–53  $\mu\text{m}$  as matrix were used as the feedstock materials for PTAW. In case of SAW, in addition to hardmetal and the above-mentioned self-fluxing alloy powders, a low carbon wire was applied as the consumable. Composition of hardfacings is presented in Table 1.

**Table 1.** Composition of hardfacings

No.	Powder composition, vol. %	Method
C5	50 WC-Co <sup>2</sup> + 50 FeCrSiB <sup>1</sup>	PTAW
B1	50 WC-Co <sup>2</sup> , 50 LCW <sup>4</sup>	SAW
B2	25 WC-Co <sup>2</sup> + 25 FeCrSiB <sup>1</sup> + 50 LCW <sup>4</sup>	SAW
D	25 WC-Co <sup>2</sup> + 25 WC-Co <sup>3</sup> + 50 LCW <sup>4</sup>	SAW

<sup>1</sup> Iron-based self fluxing alloy 6AB (Höganäs AB): Cr 13.7 wt.%, Si 2.7 wt.%, B 3.4 wt.%, Ni wt.6.0 %, C 2.1 wt.%, bal. Fe;  
<sup>2</sup> Disintegrator milled WC-Co powder (Tallinn University of Technology); particle size 1.6 – 2.0 mm;  
<sup>3</sup> Disintegrator milled WC-Co powder (Tallinn University of Technology); particle size 0.6 – 0.315 mm;  
<sup>4</sup> LCW – low carbon wire (C < 0.1 wt.%, Si < 0.03 wt.%, Mn 0.35 – 0.6 wt.%, Cr < 0.15 wt.%, Ni < 0.3 wt.%).

The PTAW hardfacing process was carried out in three steps. Firstly, the matrix self-fluxing alloy bond layer was deposited, with the deposition rate of 50 mm<sup>3</sup>/s and current of 65 A. Secondly, the hardmetal layer with thickness of ~2 mm was manually placed on that layer. Final step was the deposition of the third layer of the matrix self-fluxing alloy with the deposition rate of 40 mm<sup>3</sup>/s and current of 55 A.

The SAW hardfacing process was performed in a single pass using standard flux AMS1 (LST EN 10204:2004; SiO<sub>2</sub> 38–44 wt.%, MnO 38–44 wt.%, CaF<sub>2</sub> 6–9 wt.%, CaO < 6.5 wt.%, MgO < 2.5 wt.%, Al<sub>2</sub>O<sub>3</sub> < 5 wt.%, Fe<sub>2</sub>O<sub>3</sub> < 2 wt.%, S < 0.15 wt.%, P < 0.15 wt.%) to shield and prevent contamination of the welding area. Low carbon single electrode wire with diameter of 1.2 mm was fed at the 25.2 m/h rate into the welding zone under preliminarily chosen process parameters: welding current 180–200 A, voltage 22–24 V, travel speed – 14.4 m/h [16]. SAW was carried out with an automatic welding device – torch

MIG/MAG EN 500 78). As substrate material for production of composite hardfacings structural steel S235 (C 0.17 wt.%, Mn 0.55–0.65 wt.%, S ≤ 0.05 wt.%, P ≤ 0.04 wt.%) provided as bars with 10 × 10 mm cross-section was used. The hardfacing was deposited on 10 × 100 mm samples with hardmetal powder mixture (~ 2 mm) spread on the surface of substrate under the flux.

Hardfacings obtained using SAW were tempered after welding, at first for 1 h at 550 °C, with following tempering for 1 h at 600 °C.

Scanning electron microscope (SEM) images of hardfacings were obtained using SEM EVO MA-15 from Carl-Zeiss.

Rockwell hardness of hardfacings was measured on the wrought (as welded) and heat treated (tempered) samples using Universal hardness tester VerZus 750CCD at the load of 1470 N with diamond indenter. Vickers hardness (9.8 N) was measured using Buehler Micromet 2001 hardness tester. An average of 10 for Rockwell and 20 for Vickers hardness readings are reported in the results.

Two different wear testing methods were used to evaluate and compare wear resistance of produced hardfacings: Abrasive Emery Wear Test (AEMW) (Fig. 1) and Abrasive Wheel Wear (AWW) (Fig. 2). Technological parameters of wear test methods are given in Table 2.

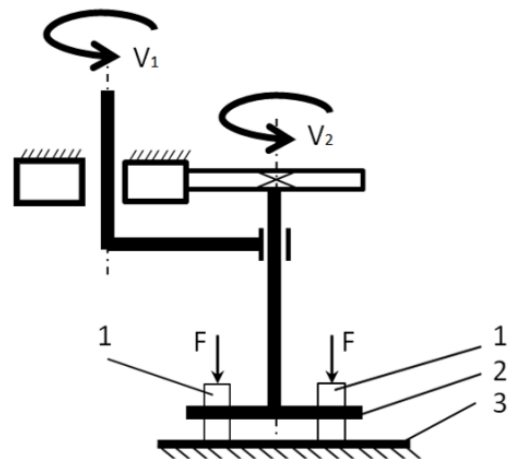

**Fig. 1.** Scheme of abrasive emery wear test: 1 – worn samples; 2 – holder; 3 – emery substrate

**Table 2.** Parameters of wear testing methods

Wear testing methods	
AEMW	Speed – 0.4 m/s, duration – 60 min, distance – 1440 m, abrasive – electrocorundum/white aluminium oxide 15A8HM with 8H mesh size
AWW	Speed – 2.4 m/s, duration – 10 min, distance – 1440 m, abrasive – SiC, particle size – 600–800 $\mu\text{m}$ ; wheel hardness – 35 HRC

Samples for AEMW test (Fig. 1) with dimensions 6 × 20 mm were pressed to the emery substrate with 5 N load. Wear samples have been rotating round the holder axis with velocity of 63 r/min. Mass loss has been checked after each 10 min of test (~ 240 m of wear path) on the scales with 0.0001 g accuracy. Electrocorundum/white aluminium oxide was used as abrasive emery substrate; it was changed every 5 min (~ 120 m of wear path).



AWW test was carried out by testing machinery assembled in Tallinn University of Technology. AWW test (Fig. 2) imitates two-body abrasive wear conditions, in which test body is pressed against revolving abrasive wheel with fixed abrasive at speeds that are similar to Abrasive Rubber Wheel Wear (ARWW) test, carried out according to ASTM G65 standard.

Each presented hardfacing C5, B1, B2, D was tested four times, and just the average results of hardness and wear were analysed and discussed.

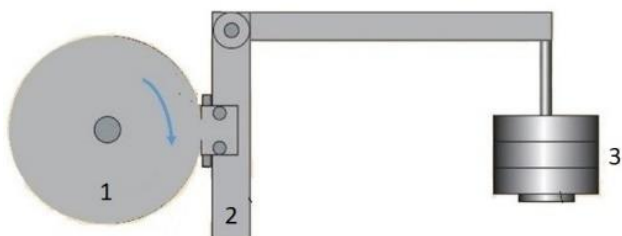

Fig. 2. Scheme of abrasive wheel wear: 1 – abrasive wheel; 2 – testbody holder; 3 – weight

### 3. RESULTS AND DISCUSSION

The purpose of multiple step tempering was to reduce the stresses and initiate transformation of possibly retained austenite [7]. After the first tempering at a temperature of 550 °C, hardness of hardfacings B1 and B2 reached 55 HRC (Table 3). Further tempering at 600 °C did not affect hardness values of this testing lot. Different results were observed for the sample D, produced from the hardmetal powder of fine and coarse fracture. Fine particles dissolved completely forming highly alloyed matrix, while coarse particles remained almost unaffected. Obviously hardness of sample D as welded was just 39 HRC, though it increased to 58 HRC and 54 HRC respectively after tempering at 550 °C and 600 °C. This is typical to the so called secondary hardening of e.g. high speed steels and high alloyed tool steels. Secondary hardness was caused by the transformation of retained austenite or by the precipitation of carbides.

Table 3. Hardness of hardfacings

Rockwell hardness of SAW hardfacings after tempering				
No.	As welded, HRC	After tempering, HRC		
		550 °C (I cycle)	600 °C (II cycle)	
B1	55	55	54	
B2	54	53	50	
D	39	58	54	
Vickers hardness, HV1				
Matrix	C5	B1	B2	D
846	1425	1441	1557	1436

The microstructures hardfacings' cross-section views produced using SAW clearly revealed hardmetal particles with narrow diffusion zones, where iron from matrix substitutes cobalt, (I) tightly distributed into the metal matrix (II) Between hardmetal particles and matrix there is also precipitation zone (III), where loose WC are precipitated in the matrix (Fig. 3, Fig. 4, Fig. 5) [19].

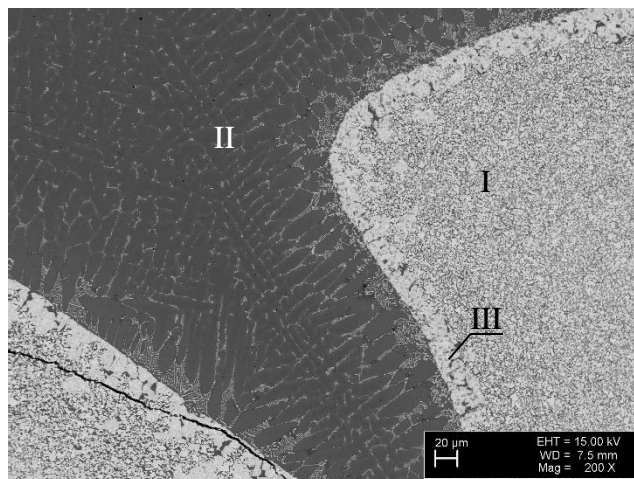

Fig. 3. Microstructures of SAW hardfacing B1: I – diffusion zone; II – metal matrix; III – precipitation zone

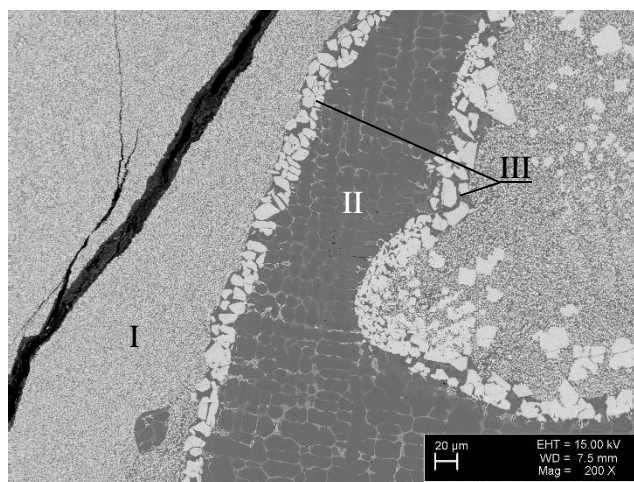

Fig. 4. Microstructures of SAW hardfacing B2: I – diffusion zone; II – metal matrix; III – precipitation zone

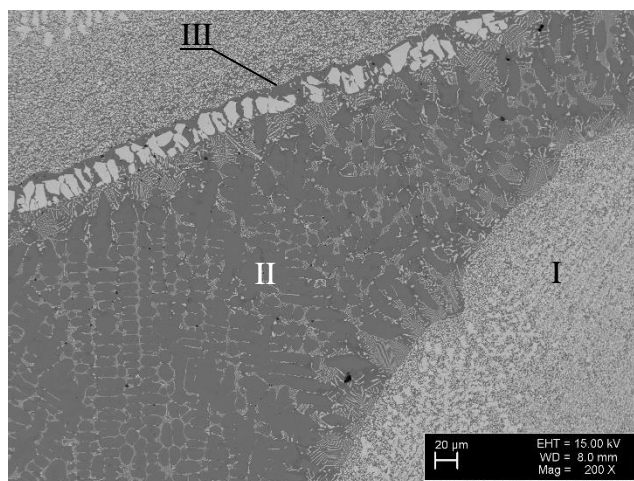

Fig. 5. Microstructures of SAW hardfacing D: I – diffusion zone; II – metal matrix; III – precipitation zone

It is clearly seen in microstructure images of hardfacings B1, B2 and D (Fig. 3 – Fig. 5) that tungsten carbide-cobalt powder particles dissolve (II) under the influence of high SAW weld pool temperature. Such a dissolution of WC-Co increases hardness of the matrix, but

probably would decrease overall wear resistance of the hardfacings [6, 16].

The solidification of hardfacings started when primary carbides were formed, followed by eutectic change of liquid solution to austenite. The ledeburitic eutectic surrounds the primary carbides and forms matrix of SAW hardfacings (dark grey sectors around the WC-Co particles). Low carbon wire and self-fluxing alloy form a matrix in the coating with a structure similar to a cast structure (II).

Some relief cracks have appeared almost in all microsections in the area of hardmetal particles during mechanical operations of sections preparations: cutting, grinding and polishing. These cracks have caused just initial increase of mass loss during wear test.

As can be seen from Fig. 6, during PTAW welding similar dissolution of hardmetal particles in the matrix takes place as in SAW (II). Amount of dissolution is in correlation with heat input during welding process. Former investigations [17] confirmed this statement: the decreased content of WC was related to thermally induced degradation from increased dissolution and increased iron content in the melt.

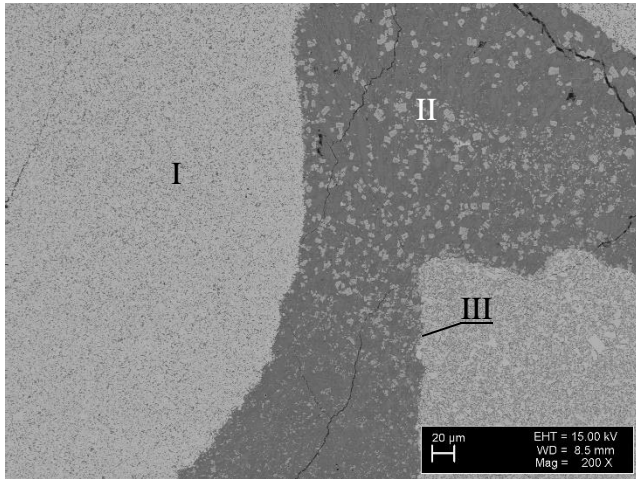
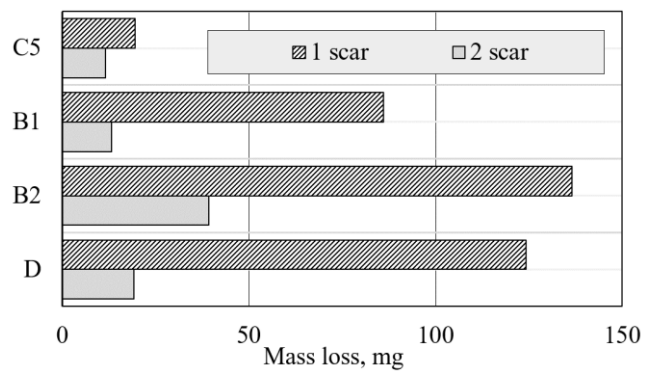

**Fig. 6.** Microstructure of PTAW hardfacing C5: I – diffusion zone; II – metal matrix; III – precipitation zone

SAW and PTAW produced hardfacings were tested in two abrasive wear conditions: emery wear (Fig. 7) and abrasive wheel wear (Fig. 8). Mass loss results were registered for two wear scars in abrasive emery wear test and four wear scars in abrasive wheel wear test. Generally, first wear scar associates with intensive wear, because heavier WC-Co particles precipitate at the bottom of coating.

Matrix material is cut out by abrasive particles at the beginning. At later test abrasive cannot reach matrix no more, so then it is protected by hardmetal particles.

As can be seen, values of first wear scar tests are quite high for the both experimental tests: maximum mass loss in AEMW was 136.4 mg, in AWW test – 126.8 mg (Fig. 7 and Fig. 8 respectively). After reaching such a high mass loss for all tested samples, it was decided by grinding operation to remove approximately the 1.5 mm from the surface of hardfacings tested on AEMW (2 wear scars), and to carry out additional wear tests on the hardfacings in the case of AWW test (4 wear scars).



**Fig. 7.** Abrasive emery wear test results of hardfacings

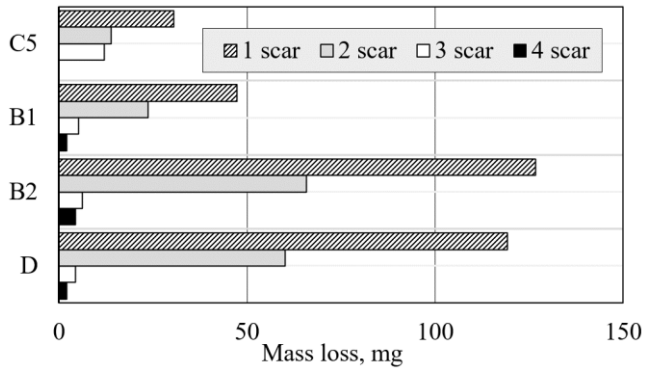

	B1	B2	D
□ 3 scar, mg	5.20	6.2	4.30
■ 4 scar, mg	2.05	4.45	2.1

**Fig. 8.** Abrasive wheel wear test results of hardfacings

Obtained results have proved the presumption that heavy hardmetal particles lay at the bottom – wear resistance of ground hardfacing B1 has been increased by 6 times: initial mass loss – 86.05 mg, after removal of superficial layer – 13.2 mg. The same tendency is seen for hardfacing D – mass loss has been decreased by 6 times too while for B2 this difference was two times lower (Fig. 7). PTAW produced hardfacing C5 was less sensitive to the second wear test after grinding – mass loss values were just 1.6 times lower.

Wear resistance of hardfacings tested on AWW machinery have been increasing after each 1440 m of wear path. It was depicted in the previous research [18] that composite hardfacings containing coarse WC-Co reinforcement (1.6–2.0 mm) suit well for two-body abrasion condition (AWW). Total length of wear path was 5760 m; as can be seen in Fig. 8, character of wear behaviour of SAW and PTAW samples in wheel test was analogous to the emery wear test. Mass loss after second test for all hardfacings was approximately 2 times lower than after the first one. The maximum reduction in worn mass loss was reached after third wear test – for all hardfacings in average by 9 times. Results of further wear test for B1, B2, and D hardfacings showed subsequent increase in wear resistance (on average twice) demonstrating suitability of produced hardfacings for long-term intensive wear, because deeper portions of coatings showed gradually increasing wear resistance.

## 4. CONCLUSIONS

Wear test results in abrasive emery wear and abrasive wheel wear test showed almost analogous tendency (when comparing first and second scars), with slightly lower wear values in AWW compared to AEMW.

PTAW produced hardfacing C5 showed better wear resistance than SAW hardfacings B1, B2, and D in both wear test conditions: mass loss of the former was by 5.9 and 2 times lower after first and second wear test respectively in abrasive emery test, and on average by 3.2 lower in abrasive wheel test.

Behaviour of SAW hardfacings B1, B2, and D is promising – third and fourth test series showed very high wear resistance, indicating that hardfacings need “working in” before achieving maximum wear resistance.

Secondary hardening effect was observed after two cycles of tempering of hardfacings produced by submerged arc welding. It led to the formation of high wear resistant substrate.

### Acknowledgments

This work was supported by institutional research funding IUT19-29 „Multi-scale structured ceramic-based composites for extreme applications“ of the Estonian Ministry of Education and Research.

This work was partially supported by Erasmus+ staff exchange program by Archimedes Foundation.

### REFERENCES

1. **Hinners, H., Konyashin, I., Ries, B., Petrzhik, M., Levashov, E.A., Park, D., Weirich, T., Mayer, J., Mazilkin, A.A.** Novel Hardmetals with Nano-Grain Reinforced Binder for Hard-Facings *International Journal of Refractory Metals and Hard Materials* 67 2017: pp. 98–104.  
<https://doi.org/10.1016/j.ijrmhm.2017.05.011>
2. **Bendikiene, R., Pupelis, E., Kavaliauskiene, L.** Effects of Surface Alloying and Laser Beam Treatment on the Microstructure and Wear Behaviour of Surfaces Modified Using Submerged Metal Arc Welding *Materials Science (Medžiagotyra)* 22 (1) 2016: pp. 44–48.  
<http://dx.doi.org/10.5755/j01.ms.22.1.7621>
3. **Bendikiene, R., Ciuplys, A., Kavaliauskiene, L.** Preparation and Wear Behaviour of Steel Turning Tools Surfaced Using Submerged Arc Welding Technique *Proceedings of the Estonian Academy of Sciences* 65 (2) 2016: pp. 117–122.  
<http://dx.doi.org/10.3176/proc.2016.2.01>
4. **Flores, J.F., Neville, A., Kapur, N., Gnanavelu, A.** An Experimental Study of the Erosion-Corrosion Behaviour of Plasma Transferred Arc MMCs *Wear* 267 2009: pp. 213–222.  
<https://doi.org/10.1016/j.wear.2008.11.015>
5. 50 Hardfacing Tips. Form no. 9220. Victor Technologies, 2012; available at <http://studylib.net/doc/18905505/50-hardfacing-tips---victor-technologies>
6. **Mendez, P.F., Barnes, N., Bell, K., Borle, S.D., Gajapathi, S.S., Guest, S.D., Izadi, H., Gol, A.K., Wood, G.** Welding Processes for Wear Resistant Overlays *Journal of Manufacturing Processes* 16 2014: pp. 4–25.  
<https://doi.org/10.1016/j.jmapro.2013.06.011>
7. **Bendikiene, R., Ciuplys, A., Pupelis, E.** Research on Possibilities to Replace Industrial Wear Plates by Surfaced Coatings using Waste Materials *International Journal of Surface Science and Engineering* 10 (4) 2016: pp. 330–338.  
<https://doi.org/10.1504/IJSURFSE.2016.077535>
8. **Chang, C.M., Chen, L.H., Lin, J.H., Fan, C.M., Wu, W.** Microstructure and Wear Characteristics of Hypereutectic Fe-Cr-C Cladding with Various Carbon Contents *Surface & Coatings Technology* 205 2010: pp. 245–250.  
<https://doi.org/10.1016/j.surfcoat.2010.06.021>
9. **Kirchgaßner, M., Badisch, E., Franek, F.** Behaviour of Iron-based Hardfacing alloys under abrasion and Impact *Wear* 265 2008: pp. 772–779.  
<https://doi.org/10.1016/j.wear.2008.01.004>
10. **Rojacz, H., Zikin, A., Mozelt, C., Winkelmann, H., Badisch, E.** High Temperature Corrosion Studies of Cermet Particle Reinforced NiCrBSi Hardfacings *Surface & Coatings Technology* 222 2013: pp. 90–96.  
<https://doi.org/10.1016/j.surfcoat.2013.02.009>
11. **Zahiri, R., Sundaramoorthy, R., Lysz, P., Subramanian, C.** Hardfacing Using Ferro-Alloy Powder Mixtures by Submerged Arc Welding *Surface & Coatings Technology* 260 2014: pp. 220–229.  
<https://doi.org/10.1016/j.surfcoat.2014.08.076>
12. **Saha, A., Mondal, S.C.** Multi-objective Optimization of Manual Metal Arc Welding Process Parameters for Nano-structured Hardfacing Material Using Hybrid Approach *Measurement* 102 2017: pp. 80–89.  
<https://doi.org/10.1016/j.measurement.2017.01.048>
13. **Kulu, P., Tarbe, R., Žikin, A., Sarjas, H., Surženkov, A.** Abrasive Wear Resistance of Recycled Hardmetal Reinforced Thick Coating *Key Engineering Materials* 527 2013: pp. 185–190.  
<https://doi.org/10.4028/www.scientific.net/KEM.527.185>
14. **Günther, K., Liefeth, J., Henckell, P., Ali, Y., Bergmann, J.P.** Influence of Processing Conditions on the Degradation Kinetics of Fused Tungsten Carbides in Hardfacings *International Journal of Refractory Metals and Hard Materials* 70 2018: pp. 224–331.  
<https://doi.org/10.1016/j.ijrmhm.2017.10.015>
15. **Surženkov, A., Baroninš, J., Viljus, M., Traksmaa, R., Kulu, P.** Sliding Wear of Composite Stainless Steel Hardfacing under Room and Elevated Temperature *Solid State Phenomena* 267 2017: pp. 195–200.  
<https://doi.org/10.4028/www.scientific.net/SSP.267.195>
16. **Liyanage, T., Fisher, G., Gerlich, A.P.** Microstructures and Abrasive Wear Performance of PTAW Deposited Ni-WC Overlays Using Different Ni-alloy Chemistries *Wear* 274–275 2012: pp. 345–354.  
<https://doi.org/10.1016/j.wear.2011.10.001>
17. **Choi, L., Wolfe, M., Yarmurch, M., Gerlich, A.** Effect of Welding Parameters on Tungsten Carbide-metal Matrix Composites Produced by GMAW *Proceedings of Canadian Welding Association Conference* 2011.
18. **Simson, T., Kulu, P., Surženkov, A., Tarbe, R., Goljandin, D., Tarraste, M., Viljus, M., Traksmaa, R.** Wear Resistance of Sintered Composite Hardfacings under Different Abrasive Wear Conditions *Materials Science (Medžiagotyra)* 23 (3) 2017: pp. 249–253.  
<http://dx.doi.org/10.5755/j01.ms.23.3.16323>
19. **Simson, T., Kulu, P., Surženkov, A., Goljandin, D., Tarbe, R., Tarraste, M., Viljus, M.** Optimization of Structure of Hardmetal Reinforced Iron-Based PM Hardfacings For Abrasive Wear Conditions *Key Engineering Materials* 721 2017: pp. 351–355.  
<https://doi.org/10.4028/www.scientific.net/KEM.721.351>