

Characterization of the Structure and Properties of Composite Powder Materials and Coatings

Renno VEINTHAL^{1*}, Priit KULU¹, Helmo KÄERDI²

¹Department of Materials Engineering, Tallinn University of Technology, Ehitajate tee 5, 19086 Tallinn, Estonia

²Department of Mathematics, Estonian National Public Service Academy, Kase 61, 12012 Tallinn, Estonia

Received 08 June 2005; accepted 02 August 2005

Tribological materials and coatings are typical composite materials of heterogeneous structure: hard particles in a relatively soft matrix. For the modelling of wear of homogeneous bulk materials the models of plastic deformation and brittle fracture are developed. To use the model for wear calculation, the following parameters characterizing materials were found necessary: parameters of hardness distribution, shear energy density, characterizing material removal at plastic deformation, fracture toughness characterization of the brittle fracture mechanism and fracture probability parameter. The above mentioned materials characteristics were found, wear rates were calculated and experimentally determined. The comparison of wear rates of coating demonstrated that the used mathematical models for describing erosion wear are adequate. The calculated values of the wear rates of the given metal-matrix composite material differed from the experimental results of erosion wear tests at high impact angles about 3 – 4 times.

Keywords: metal-matrix composite, erosion, hardness distribution, fracture probability.

1. INTRODUCTION

In many cases tribological materials and coatings are typical composite materials of heterogeneous structure: hard particles in a relatively soft matrix. Typical representatives of wear resistant materials are metal-matrix composites (MMC) with particulate hard reinforcement, nickel and cobalt self-fluxing alloy-based coatings and carbide-based materials and coatings with a metal binder. Tungsten carbide (WC) based hardmetal-type coatings or self-fluxing alloys-based coatings containing WC, applied by spray and fusion methods, are used. At impact wear the plastic contact is dominating by the metal-matrix materials and coatings and the model of plastic deformation is applicable. With the hardmetal-type materials and coatings, where carbide content exceeds 50 %, brittle fracture of carbide dominates [1, 2]. For the modelling of wear of homogeneous bulk materials the models of plastic deformation and brittle fracture are developed [3, 4].

With composite materials of the metal-matrix structure, both models must be taken into consideration: by a relatively soft metal matrix – the model of plastic deformation (Eq. (1)), by the hard-phase – the models of plastic deformation and brittle fracture (Eqs. (1) and (2)). Weight wear rate from plastic deformation I_g^p can be expressed as follows [3].

$$I_g^p = \frac{3}{4\pi} \cdot \frac{\rho_1}{\rho_2} \cdot \frac{\tau_0}{e_s} \left[6.81 \left(\frac{h_p}{R_2} \right)^{0.5} \cdot \frac{2\rho_2}{3H_1} v_0^2 \cdot \cos^2 \alpha + 0.85 \left(\frac{h_p}{R_2} \right)^2 \right]. \quad (1)$$

Eq. (1) is valid, when the hardness of abrasive particles H_2 has to exceed that of material H_1 by 1.6 times as a minimum. Weight wear rate from brittle fracture I_g^b can be calculated, using Eq. (2) [4].

$$I_g^b = \frac{\Delta m}{M} = \frac{\pi \cdot C_r^2 h_l \cdot \rho_1}{\left(\frac{4}{3} \right) \pi R^3 \rho_2} = 0.75 \cdot \sqrt{3} \frac{\rho_1}{\rho_2} \left(\frac{C_r}{R_2} \right)^2 \cdot \left(\frac{h_p}{R_2} \right)^{0.5}, \quad (2)$$

where ρ_1 and ρ_2 – density of the material and abrasive particle, R_2 – radius of the abrasive particle, H_1 – hardness of the material, v_0 – particle velocity, α – impact angle, h_p – depth of the penetration/indentation, C_r – length of the radial crack, h_l – depth of the lateral crack, τ_0/e_s – shear energy density.

As a result of checking the models by Beckmann and Gotzmann [3, 4], the following parameters characterizing materials were found to be necessary:

- parameters of hardness distribution,
- shear energy density τ/e_s , characterizing material removal at plastic deformation,
- fracture toughness, characterizing of the brittle fracture mechanism,
- fracture probability parameter.

The aim of this study was to characterize the powder composite structures using the indentation methods and to apply the obtained material characteristics for erosion wear calculations.

2. EXPERIMENTAL

2.1. Studied materials

In the experiments and calculations, the following materials served as examples:

- thermal spray-fused self-fluxing NiCrSiB-alloy based composite coating, consisting of about 20 vol% (WC-Co) hardmetal reinforcement with particle size about 50 – 100 μm .
- FeCr-alloy based PM produced MMC material, containing about 20 vol% of VC micrometrical particles and about 20 vol% of WC reinforcement with particle size about 100 μm .

Table 1 presents initial data for the calculation of the erosion wear of the composite material and the coating and Fig. 1 shows their microstructures.

*Corresponding author. Tel.: + 372-620-3361; fax.: + 372-620-3196.
E-mail address: veinthal@staff.ttu.ee (R. Veinthal)

Table 1. Initial data for the calculation of the erosion wear of composite metal-matrix structures

Components	ρ_1 , kg/m ³	H_1 (HV), GPa	E_1 , GPa	μ_1
Matrices				
– NiCrSiB	8900	5.6	175	0.21
– FeCr-VC	7400	6.8	220	0.28
Hard phases				
– WC	15800	24.6	680	0.22
– WC-15Co	14500	14.0	560	0.23
			E_2	μ_2
Quartz-sand $R_2 = 0.1$ mm	2200	11.5	90	0.17

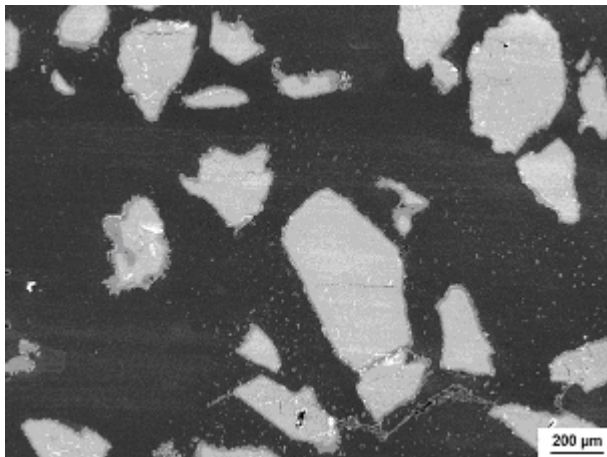

a

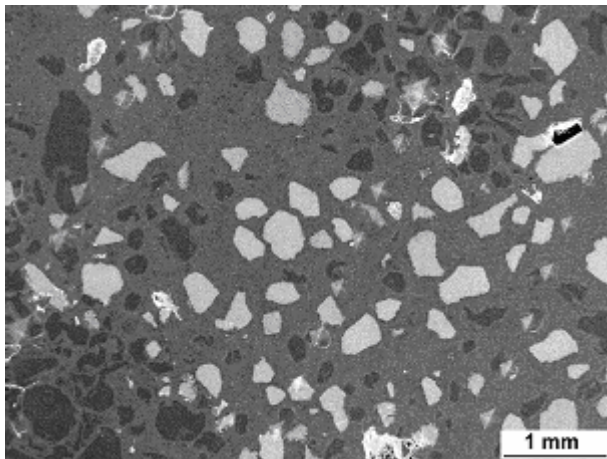

b

Fig. 1. Micrograph of the cross-section of: a – (FeCr-VC) + WC composite, b – NiCrSiB- (WC-Co) coating

2.2. Hardness measurement

Depending on the material microstructure different hardness scales and hardness measuring methods were used:

- universal hardness for macroheterogeneous self-fluxing NiCrSiB+(WC-Co) coating using hardnessmeter Zwick Z2.5 and load of 9.8 N;

- microhardness for microheterogeneous MMC with multimodal reinforcements using microhardnessmeter Micromet 2001 and a load of 1 N.

2.3. Laboratory testing of erosion wear

Determination of erosion wear rate experimentally was conducted in an abrasive particle jet. Solid particle erosion tests have been performed in a conventional centrifugal four-channel accelerator [1], in which up to 15 specimens can be treated simultaneously under identical testing conditions. The abrasive – quartz sand particles used in these experiments were rounded particles of diameter 0.1 – 0.3 mm. Steady state erosion rate was studied as a function of the impact angle at abrasive particle velocities of 50 and 80 m/s. Steel of 0.45 % C was adopted as a reference material.

3. RESULTS AND DISCUSSION

3.1. Hardness distribution

At the NiCrSiB+(WC-Co) coating altogether 144 measurements were performed. The hardness measured ranged from 439 to 13 250 MPa. Ten values of hardness close to zero and one according to the hardness distribution function (5 maximum and 5 minimum ones) were excluded [5].

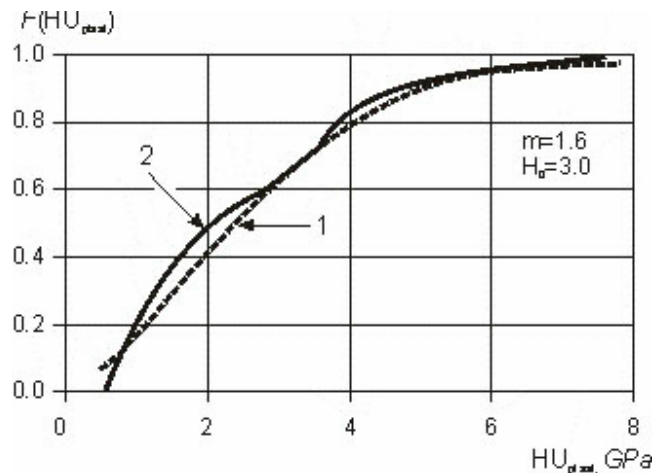

a

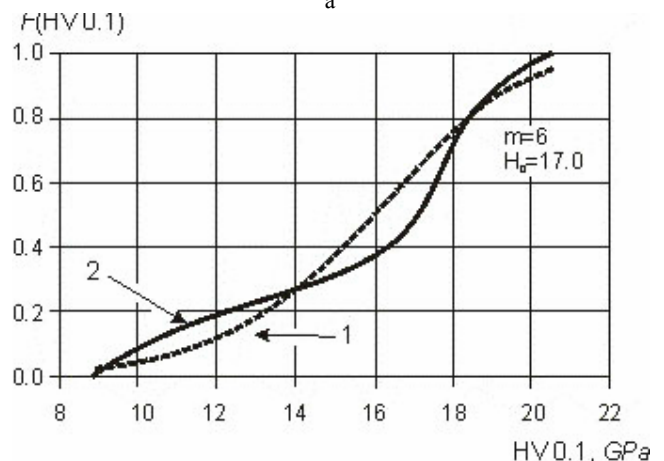

b

Fig. 2. Theoretical (1) and experimental (2) distribution functions of hardness: a – (FeCr-VC) + WC composite, b – NiCrSiB + (WC-Co) coating

Therefore, the hardness of the area from $H' = 570$ to $H'' = 7855$ MPa was taken into consideration. The hardness area was divided into $n = 6$ intervals: 570 – 1784 (with a mean value of interval 1177), 1785 – 2998 (2392), 2999 –

4212 (3606), 4213 – 5426 (4820), 5427 – 6640 (6034) and 6641 – 7855 (7248) MPa. The length of an interval $\Delta H/n = 1214$ MPa.

At the (FeCr-VC)+WC composite the hardness taken into consideration ranged from 4540...19040 MPa. The mean values of six hardness intervals were as follows: 4540, 7440, 10340, 13240, 16140, and 19040 MPa with the length of an interval 2900 MPa.

On the basis of experimental data, the Weibull cumulative distribution function $F(HU)$ and $F(HV0.1)$ parameters m and H_0 were found. The obtained values of parameters were: $m = 1.6$ and $H_0 = 3.0$ for coating and $m = 6.0$ and $H_0 = 17.0$ for the PM composite, respectively. The theoretical and experimental distribution functions are shown in Fig. 2. As it follows from Fig. 2, the experimental hardness distribution proved a good coincidence of the Weibull distribution parameters m and H_0 . For these six mean values of hardness intervals, the plastic penetration depth of indentation h_p and the corresponding radii of indentation r_n , were found.

3.2. Shear energy density

The shear energy density parameter τ_0/e_s is a dimensionless ratio, where the numerator means shearing stress τ_0 and denominator e_s – specific shear energy density in the target material.

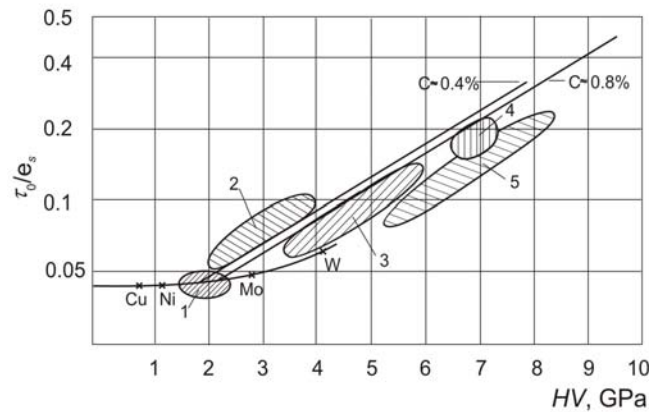

Fig. 3. Variation of τ_0/e_s as a function of initial hardness HV of the target material: 1 – austenitic manganese steels, 2 – non-alloy and low-alloy steels, 3 – alloyed (with Mn, Si, Cr) and cast steels, 4 – hardened steels, 5 – high carbon and high alloyed steels (high speed, ledeburitic etc), white cast irons

Table 2. Values of τ_0/e_s

Type of material	Metal matrix	Hard phase
NiCrSiB + (WC-Co)	0.05 – 0.1	0.1 – 0.3
(FeCr-VC)+WC	0.1 – 0.13	0.3 – 1.0

According to Beckmann and Gotzmann, the ratio τ_0/e_s is a universal parameter used to determine the wear resistance of metals. On the basis of statistical data, a graph (Fig. 3) has been composed on pure metals, carbon and alloy steels and white cast irons [3].

The values of parameter τ_0/e_s as for matrices and hard phases were determined (Table 2) according to the mean hardness (correspondingly about 3000 and 6600 for coating and 4540 and 13240 MPa for PM composite).

3.3. Indentation toughness

In the models of Beckmann and Gotzmann, hardness and fracture toughness emerge as the main material parameters that control erosion; a high hardness increases resistance to plastic deformation, while high fracture toughness increases resistance to fracture.

In our experiments, the fracture toughness of the hard phase was determined using the Palmqvist method [6]. According to this fracture toughness K_{1c} was calculated via relationship:

$$K_{1c} = \frac{\alpha \cdot F}{a \cdot l^{1/2}}, \quad (3)$$

where F – applied indenter load, a – the indentation half diagonal, l – the surface Palmqvist crack length, α – empirical, semi-empirical or theoretical constant.

The indentation pattern and cracks measured are shown in Fig. 4.

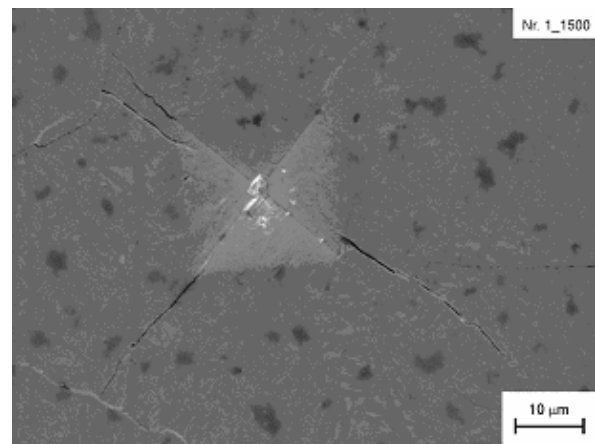

Fig. 4. WC carbide particle with radial cracks starting at the corner of Vickers indent

As an approximated model for material removal due to impact, a cylinder shape cavity will be used. As a radius of the cylinder, the middle length C_r of a radial crack outgoing from the impact centre will be employed. Cylinder height h_i corresponds to the depth of the cavity caused by the surface-parallel lateral crack. According to [4], the middle length of the radial crack C_r can be calculated as

$$C_r = \lambda \left(\frac{v_0^2 \cdot R^2 \cdot \rho_2}{K_{1c}} \right)^{2/3}. \quad (4)$$

Constant λ depends on the crack geometry, its value is approximately 0.5.

3.4 Fracture probability

The process of material removal starts after a relatively small number of irreversible deformations, i.e., contacts between abrasive particles and the target. During an indentation process, i.e., pressing a hard particle in an elastic deformable basic body, the contact hardness H_c may be determined [3]. From hardness H_c , the elastic contact appears, while values under it lead to irreversible deformations:

$$H_c = E' \left(\frac{5\pi\rho_2 R_2 v_0^2 \cdot \sin^2 \alpha}{4E'} \right)^{0.2}, \quad (5)$$

where E' – reduced modulus of elasticity of contact.

Cracks which reach far beyond the deformation cup are likely to occur and thus the brittle failure mechanism will be initiated. The probability of a fracture or crack initiation p was determined by the normal force F_n caused by the bulging particle in the contact. It is to be expected that besides force F_n , the hardness H_1 and fracture toughness K_{1c} of target material will have an influence on the probability p of a crack initiation and on the transition behaviour. Thus, with the contacts that cause crack initiation and the total number of irreversible contacts, four variables (F_n , H_1 , K_{1c} and p) exist which influence the process. This number of variables can be reduced according to the Buckingham theorem of two dimensionless parameters, such as probability p and the value of $F_n \cdot H_1^3 / \text{const} \cdot K_{1c}^4$.

In addition, it is assumed that between these dimensionless parameters the Weibull distribution is valid, expressed by the cumulative probability function

$$p = F(F_n) = 1 - \exp\left\{-\left(\frac{F_n \cdot H_1^3}{\text{const} \cdot K_{1c}^4}\right)^m\right\}, \quad (6)$$

with parameters $(\text{const} \cdot K_{1c}^4) / H_1^3$ and m .

Table 3. Measured or calculated data characterizing the contact

Components	K_{1c} , MPa·m ^{1/2}	E' , GPa	H_c , GPa		K_{1c}^4 / H_1^3 , N
			$\alpha = 30^\circ$	$\alpha = 90^\circ$	
Matrices					
– NiCrSiB	75	61.5	2.8	2.4	180
– FeCr-VC	15	66.8	1.8	2.1	161
Hard phases					
– WC	5 – 11	82.0	3.5	3.0	$8.7 \cdot 10^{-5}$
– WC-15Co	12	80.1	3.4	2.96	$7.6 \cdot 10^{-3}$

3.5. Calculation of erosion wear

Based on these six mean values of hardness intervals, the wear rates I_g^p of metal matrix from plastic contact (Eq. (1))(up to hardness 4820 MPa for a coating and 4540 MPa for a PM composite, respectively) were calculated and the wear rates of hard phase I_g^b from the brittle fracture (Eq. (2)) and I_g^p from plastic deformation were calculated. The values of parameter τ_0/e_s , determined by help of Fig. 3 (Table 2), for a coating and PM composite 0.06 and 0.1 were chosen for matrices and 0.15 and 0.5 for hard phases, respectively.

By a PM composite for the hard phase (WC) the middle length of the radial crack C_r in Eq. (2) was calculated by Eq. (4). The total wear rate I_g of the hard phase was finally calculated according to Eq. (8) as a sum, containing I_g^p and I_g^b with weights in each interval of hardness (from 7440 up to 19040 MPa, Table 5) with the product $f(H_i) \Delta H / n$,

$$I_g(H_i) = \left\{ I_g^b(H_i) \cdot p(H_i) + I_g^p(H_i) \cdot [1 - p(H_i)] \right\} \cdot f(H_i) \cdot \frac{\Delta H}{n}, \quad (7)$$

The results are given in Tables 4 and 5.

The results of the calculation of wear and experiments of (FeCr-VC)+WC composite and NiCrSiB+(WC-Co) coating are given in Table 6 and shown in Fig. 5.

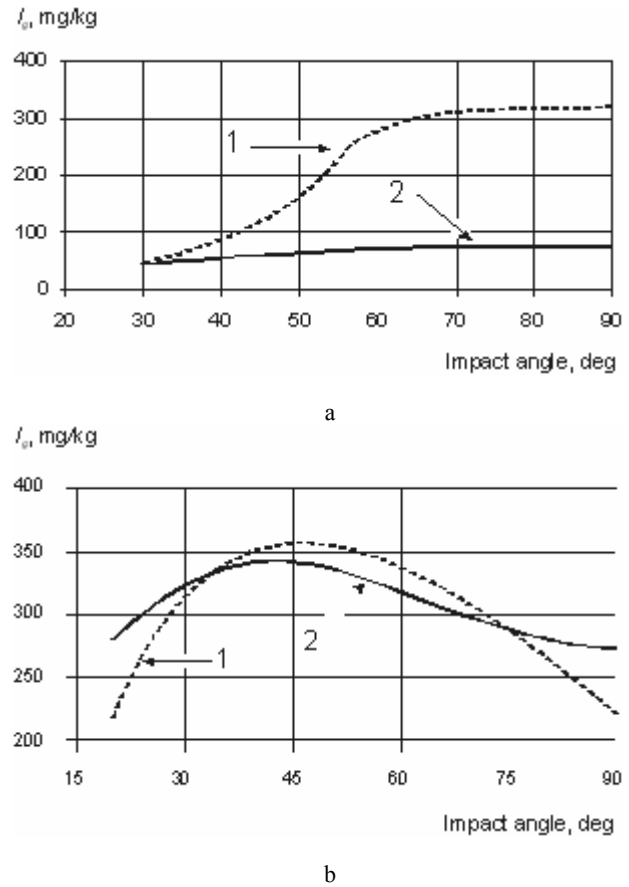

Fig. 5. Dependence of calculated (1) and experimental (2) wear rates of materials on the impact angle: a – (FeCr-VC) + WC composite, b – NiCrSiB + (WC-Co) coating

The calculated and experimental results of the wear rates of Ni-based matrix composite coating with a relatively low hardness ($H_m < H_a$) had a very good coincidence (Fig. 5, b).

The calculated and the experimental results of the wear rates of PM composite with multimodal reinforcement and a relatively high content and particle size showed a major difference. This difference (the experimental curve is flatter – Fig. 5, a) indicates that fracture toughness parameters characterizing the brittle fracture mechanism should be accurately determined.

It can be explained as follows: calculations of the wear rate of a material were based on the material characteristics determined experimentally first, on the fracture toughness parameter K_{1c} value. In our experiments, the fracture toughness of the hard phase was determined using the Palmqvist method. Regardless of the test procedure simplicity – the fracture toughness was calculated on the crack length, caused by indenting of Vickers pyramid into the material – its exact measurement is complicated and the uncertainty of the K_{1c} values determined by the Palmqvist method may exceed up to 10–20%. The numerical verification of the model showed that the relative change of 10% in K_{1c} can significantly influence the calculated wear rate values.

Table 4. Results of calculation of erosion wear of NiCrSiB + (WC-Co) coating ($v = 80$ m/s, abrasive – quartz sand 0.1 – 0.3 mm)

HU _{plast} , MPa	τ_0/e_s	p_i		I_g^p , mg/kg Eq. (1)		I_g^b , mg/kg Eq. (2)		I_g , mg/kg Eq. (8)	
		30°	90°	30°	90°	30°	90°	30°	90°
1177	0.06	0	0	597	393	0	0	176	116
2392				254	193			72	55
3606				155	128			29	24
4820				109	96			11	10
6034	0.15	0.616	0.944	339	311	799	1132	29	50
7248		0.664	0.964	270	258	759	1080	11	19
								328	274

Table 5. Results of calculation of erosion wear of (FeCr-VC) + WC composite coating ($v = 50$ m/s, abrasive – quartz sand 0.1 – 0.3 mm)

HV0.1, MPa	τ_0/e_s	p_i		I_g^p , mg/kg Eq. (1)		I_g^b , mg/kg Eq. (2)		I_g , mg/kg Eq. (8)	
		30°	90°	30°	90°	30°	90°	30°	90°
4540	0.1	0	0	52.8	54.9	0	0	39.3	40.9
7440	0.5	0.188	1.0	60.5	70.0	2836	4091	2.4	17.1
10340		0.085	1.0	157	225	2239	3664	6.9	75.8
13240		0	1.0	0	113	0	3081	0	185
16140		0	0	0	0	0	0	0	0
19040		0	0	0	0	0	0	0	0
								48.6	318.8

Table 6. Calculated and experimental values of wear rates, mg/kg of the observed PM composite and coating

Impact angle, deg	(FeCr-VC) + WC composite		NiCrSiB + (WC-Co) coating	
	Calculated	Experimental	Calculated	Experimental
20	–	–	282	219
30	48.6	44	328	319
45	118	–	344	356
60	281	70	320	342
75	312	–	288	289
90	318.8	72	274	223

4. CONCLUSIONS

The concept of plastic deformation and brittle fracture can be applied to the calculation of wear materials with a composite structure. By a relatively soft metal matrix, the energetic theory of wear using the mean hardness and dimensionless specific energy parameter τ_0/e_s is applicable. In the wear calculations of the hard phase, hardness distribution, its weights and fracture probability must be taken in to consideration.

The following conclusions can be drawn from the comparison of the results calculated by the used models and the experimental results of two types of materials with a composite structure:

– the comparison of wear rates of coating demonstrated that the used mathematical models for describing erosion wear are adequate.

– the calculated values of the wear rates of the given PM composite differed from the experimental results of erosion wear tests at high impact angles about 3 – 4 times (the calculated values are higher).

Acknowledgements

The authors are grateful to Prof. Ilmar Kleis for his advice concerning the application of the energetic theory of wear and the interpretation of the results of wear calculations.

REFERENCES

1. **Kulu, P.** The Abrasive Erosion Resistance of Powder Coatings *J. Tribologia: Finnish J. Tribology* 8 (4) 1989: pp. 12 – 25.
2. **Kulu, P., Veinthal, R., Kõo, J., Lille, H.** Mechanism of Abrasion Erosion Wear of Thermal Sprayed Coatings *Advances in Mechanical Behaviour, Plasticity and Damage, Proc. of EUROMAT 2000*, Tours, 2000: pp. 651 – 656.
3. **Beckmann, G., Kleis, I.** Abtragverschleiss von Metallen. Leipzig, 1983: 184 s. (Distributed by Springer – Verlag Wien – New York).
4. **Gotzmann, J.** Modellierung des Strahlverschleißes an Keramischen Werkstoffen *Schmierungstechnik, Fachzeitschrift für Tribotechnik* VEB Verlag Technik Berlin 20 11 1989: s. 324 – 329.
5. **Tabor, D.** The Hardness of Metals, Oxford Univ. Press, 1951.
6. **Ponton, C., Rawlings, R.** Vickers Indentation Fracture Toughness, Part 1: Test Review of Literature and Formulation of Standardised Indentation Toughness Equation *Mater. Sci. Technol.* 5 1989: pp. 865 – 870.